

# Two-beam active infrared intrusion detector

## Installation guide

### ABT series

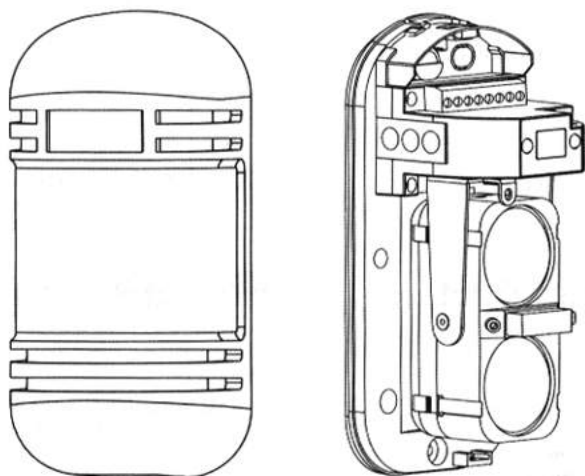

P/N:21160604B01

## I. Model and specifications

Model	ABT-20	ABT-30	ABT-40	ABT-60	ABT-80	ABT-100	
Warning distance	(outdoor)	20m	30m	40m	60m	80m	100m
	(Indoor)	60m	90m	120m	180m	240m	300m
Number of beams	2 beams						
Detection method	2 beams simultaneously interrupted detection type						
Detection distance	≤100m (open area)						
Product size	(L*W*H) 170*81.5*80.5mm						
Light source	Infrared digital pulse type						
Power supply voltage	DC12V~24V						
Alarm signal threshold	≤0.5V						
Alarm output	Relay contact output NO. NC						
Waterproof rating	IP55						
Condensation and frost countermeasures	heating housing (optional), optional heater						
Current consumption	≤100mA (a pair)						
Working environment	-25℃~+55℃						
Optical axis adjustment angle	180° (±90°)						
Optical axis adjustment angle	20° (±10°)						
Material quality	PC engineering material						

## II. Part name

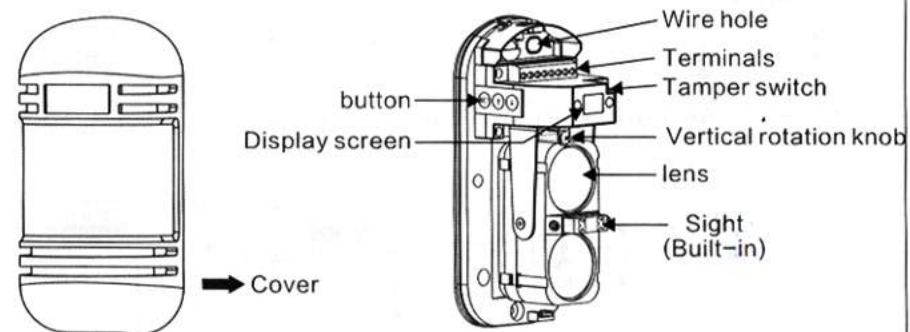

### III. Function introduction

1. Working principle: The light emitted by the transmitter directly enters the receiver. When the detected object passes between the transmitter and the receiver to block the light, the detector generates an alarm signal.

2. Alarm function: When someone crosses the monitoring protection zone, the invisible infrared beam is interrupted to trigger an alarm, and the detector will send an alarm signal to the host.

3. Intelligent heating function (optional): the receiver and transmitter have built-in iron-aluminum alloy, which can be connected to a 5V heater (optional). When the ambient temperature is lower than 5°C, the HEAT terminal will output a 5.5V voltage to the heater. Power supply can effectively prevent light blocking caused by haze and low temperature.



4. Anti-disassembly function: This product has a tamper-proof switch, which can trigger an alarm when the outer cover is loose under working conditions.

### IV. Function mode setting

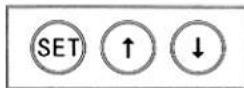

#### 1. Receiver settings

Please refer to the following flow chart for setting.

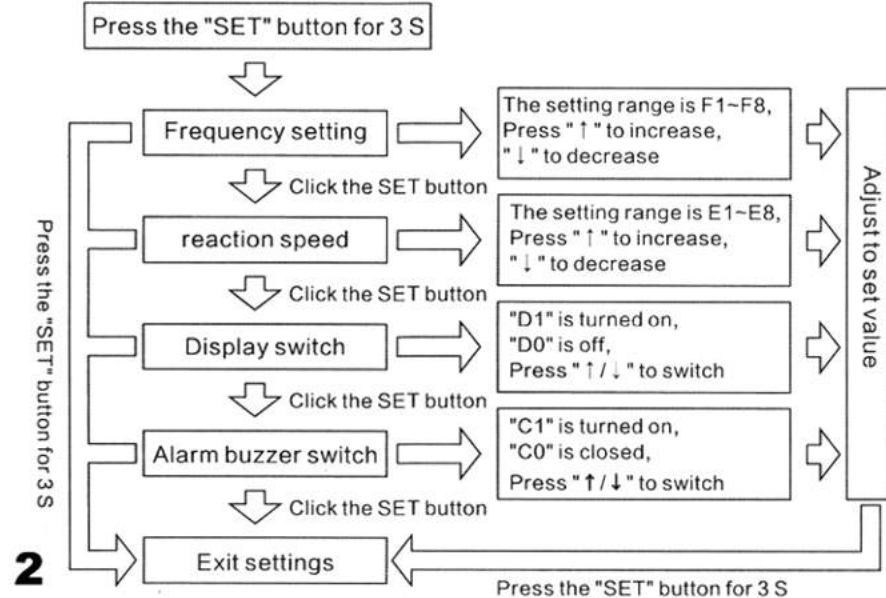

2

• Response speed setting: the speed when the detected object passes between the transmitter and the receiver to block light. Generally, the speed should be less than the speed required by the intruder to pass through the warning surface. It can be set to 8 gears (E1 ~E8) Alarm response speed (shading time), the smaller the number of gears, the faster the response speed. The shading time is 40ms~180ms, please refer to the following figure for adjusting the shading time.

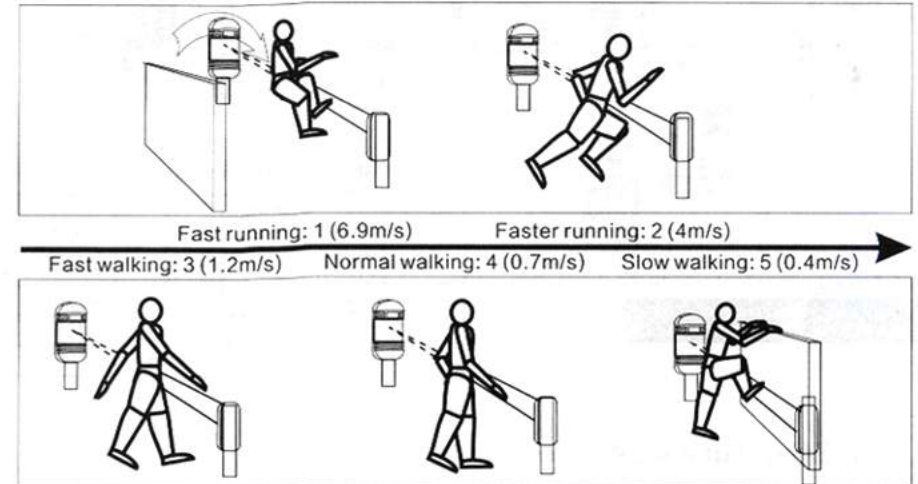

• Display switch: Whether the display shows the signal strength during normal working hours of the radio. If the setting is turned on, the current signal strength will be displayed, and it will not be displayed when it is turned off.

• Alarm buzzer switch: whether the buzzer sounds when the alarm is triggered

#### 2. Launcher settings

8 transmitting frequencies can be set. The setting of the transmitter frequency should be consistent with the receiving frequency. The red lights on the transmitter represent 1, 2, 4, and 8, from left to right. Press the "SET" key to start the frequency Switch. Frequency indicator comparison table:

Indicator status				
Transmit frequency	Frequency 1	Frequency 2	Frequency 3	Frequency 4
Indicator status				
Transmit frequency	Frequency 5	Frequency 6	Frequency 7	Frequency 8
Remarks	● means the indicator light is always on; ○ means the indicator light is off			

3

## V. Receiver indicator light description

After completing the settings, a walking test must be performed. Please refer to the figure below to confirm whether the alarm is triggered.



## VI. Installation precautions

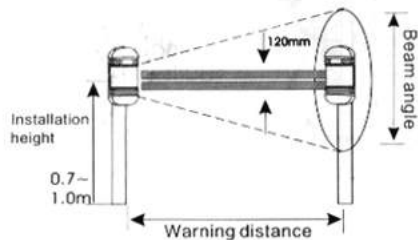
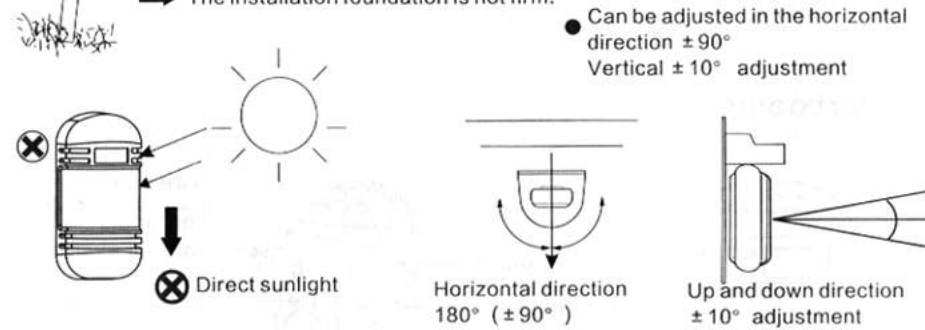
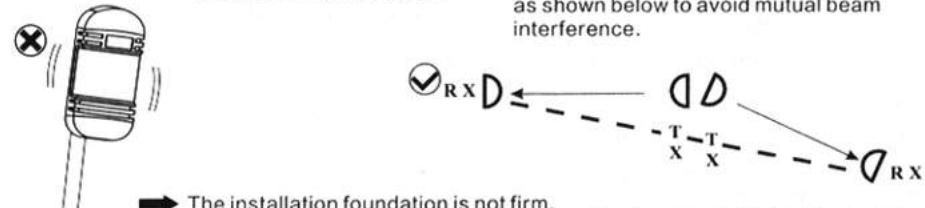
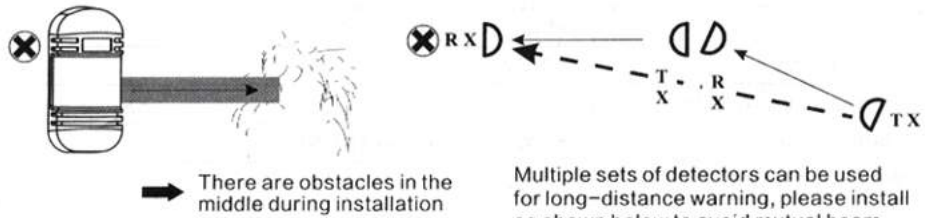

4

Model	Warning distance	Beam angle
ABT-20	20m	0.6m
ABT-30	30m	0.7m
ABT-40	40m	1.0m
ABT-60	60m	1.5m
ABT-80	80m	1.8m
ABT-100	100m	2.1m

## VII. Installation method

1. Remove the fixing screws and remove the cover

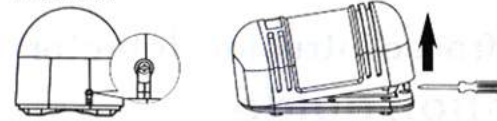

2. Stick the attached Mountable paper to the place to be installed, and punch holes according to the holes

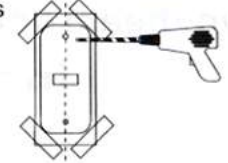

3. Pass the cable through the cable hole for wiring

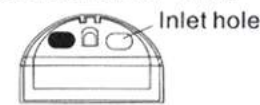

4. Fix the body on the wall

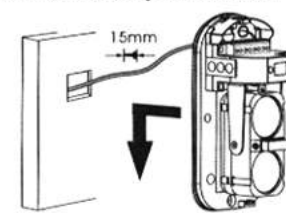

5. Connect the cable to the terminal

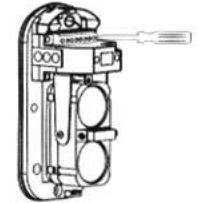

Please refer to the following diagram for wiring.

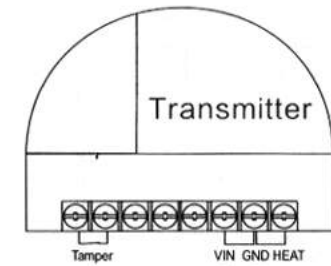
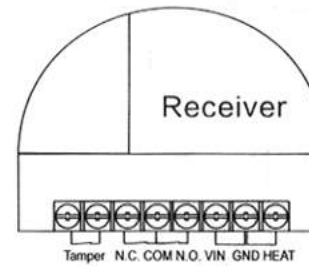

6. Optical axis adjustment

A. Observe the aiming effect at 5cm of the scope so that the image of the opposite detector falls into the middle of the aiming hole.

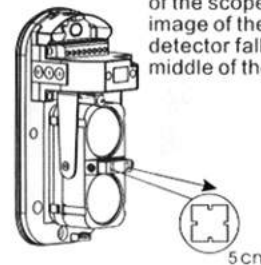

B. Adjust the upper and lower angle adjustment screws and the horizontal adjustment wheel. At this time, the received signal strength is gradually increased. When the signal strength is less than 1.8, please continue to adjust the optical axis.

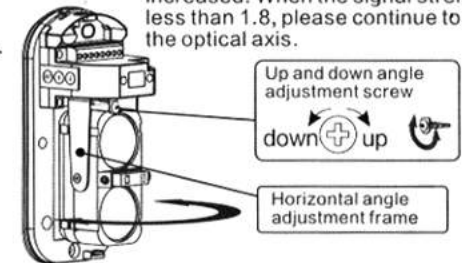

7. After finishing the optical axis adjustment, install the cover.

5

## ● Fixed bracket installation method

1. Open the lead hole on the bracket and lead out the cable



2. Remove the cover

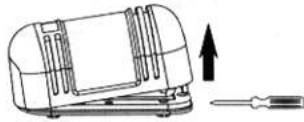

3. Fix the machine on the bracket

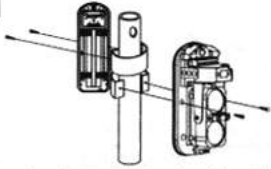
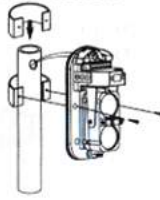

(Reference drawing for back-to-back installation)

Note: Please add waterproof plugs to the screw holes when installing.

Wiring distance between power supply and bus

distance Wire diameter	Voltage	
	DC12V	DC24V
0.5mm <sup>2</sup> ( $\phi$ 0.8)	300m	600m
0.75mm <sup>2</sup> ( $\phi$ 1.0)	400m	800m
1.25mm <sup>2</sup> ( $\phi$ 1.2)	700m	1400m
2.0mm <sup>2</sup> ( $\phi$ 1.6)	1000m	2000m

## VIII. Structure size

Dimensions

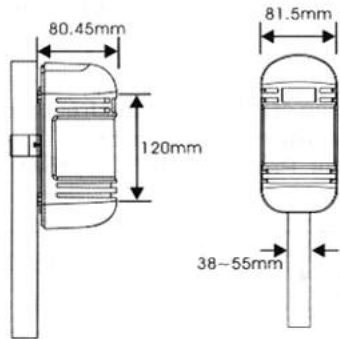

Mounting bracket  
(optional)

L bracket  
80×75mm



T bracket  
T-100  
100×120mm  
T-200  
200×120mm



I bracket  
I-100  
100mm  
I-200  
200mm

